

ISS.	AMEND	DATE
1	ISSUED	26/02/14

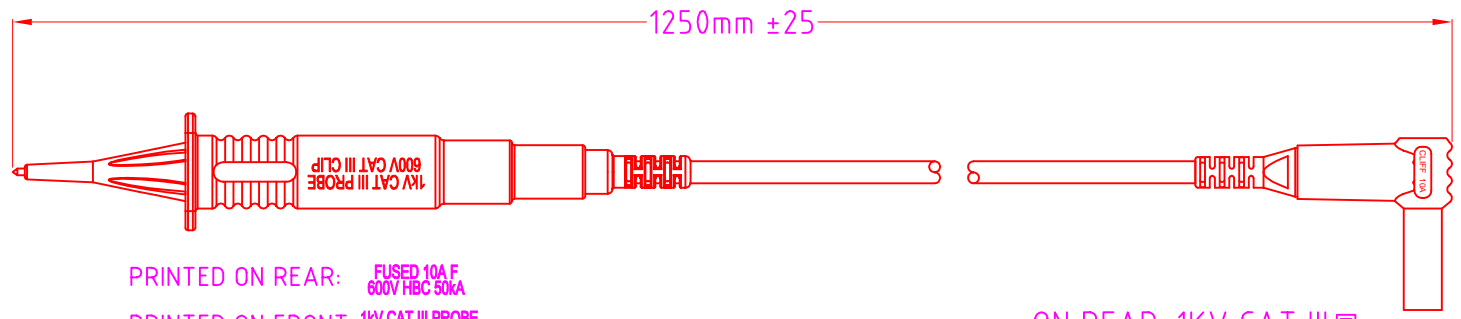

PRINTED ON REAR: FUSED 10A F
600V HBC 50kA
PRINTED ON FRONT: 1KV CAT III PROBE
600V CAT III CLIP

ON REAR: 1KV CAT III

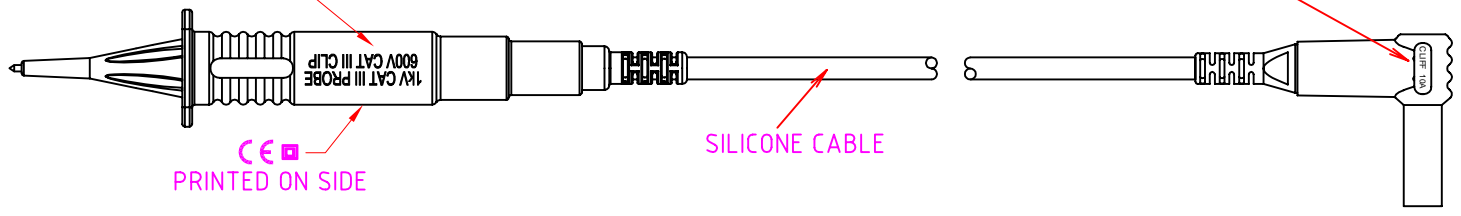

CE
PRINTED ON SIDE

SILICONE CABLE

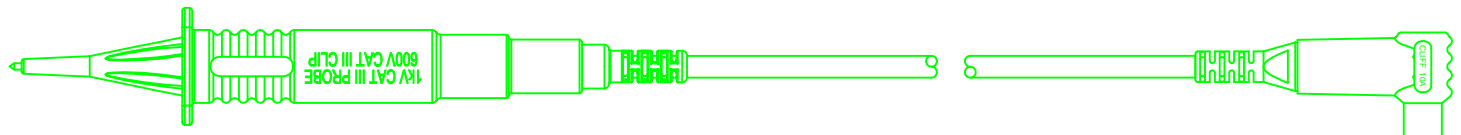

Ø7.8

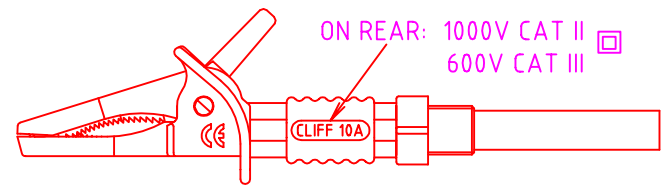

ON REAR: 1000V CAT II
600V CAT III

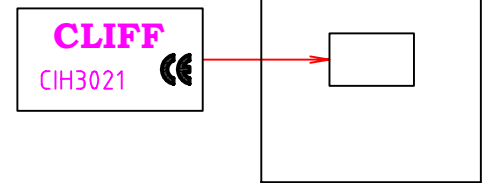
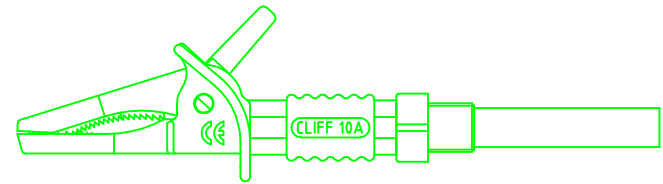
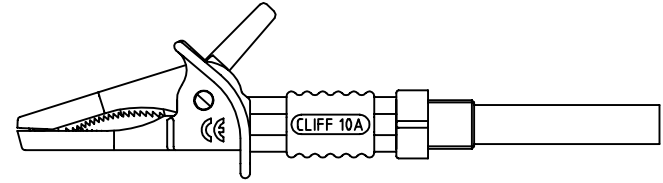

PACK 6x ITEMS

- 1x RED LEAD
- 1x BLACK LEAD
- 1x GREEN LEAD
- 1x RED SCREW IN CROC CLIP
- 1x BLACK SCREW IN CROC CLIP
- 1x GREEN SCREW IN CROC CLIP

LEAD RATING

1kV CAT III WITH PROBE
600V CAT III WITH CROCS CLIPS
FUSE: 600V F10A (SIBA 7009463.10)

RoHS
COMPLIANT

TOLERANCE
NO DEC. PLACE ±
1 DEC. PLACE ±
2 DEC. PLACE ±
HOLE Ø ±
ANGLES ±
UNLESS OTHERWISE STATED

WHEN ORDERING USE CLIFF PART NUMBER: CIH3021